

**599
LAB**

Battery Pack LAB599 BP-500

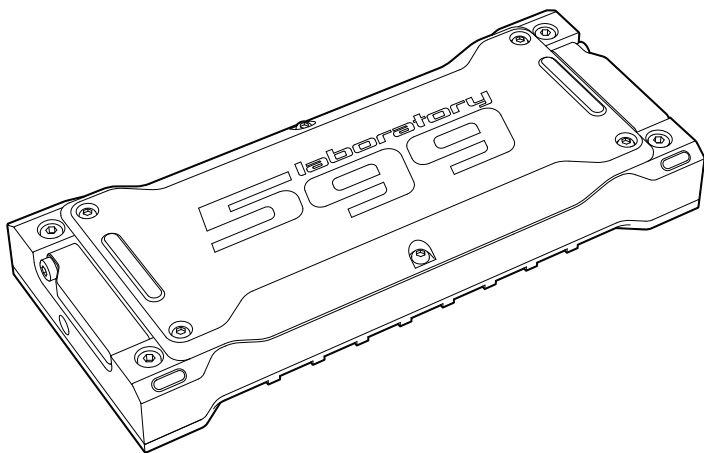

USER MANUAL

v1.0 / 03.2023

Description and Specifications	3
Appearance and controls	4
Maintenance	6
Connection and control	7
Safety and operating conditions	10

DESCRIPTION

The BP-500 battery pack is designed to be directly attached to the Lab599 Discovery TX-500 transceiver and provide power to the transceiver from interchangeable Li-Ion 18650 cells (rated voltage 3.7V).

The wide charging voltage range of 13 to 50V allows the battery pack to be charged from a variety of DC power sources: home electronics power supplies, electrical on-board network of various vehicles, solar panels. Provides protection against overheating, polarity reversal.

The battery pack has an indication of the remaining battery charge. When connected to the Discovery TX-500 transceiver, additional battery information is available on the transceiver screen.

BP-500 FEATURES:

- Direct attachment to the Lab599 Discovery TX-500 transceiver without the need for additional cabling;
- Interchangeable Li-Ion 18650 batteries;
- Ability to use 3 or 6 batteries;
- Wide charging voltage range from 13 to 50 V;
- Ability to charge from solar panels;
- Four segment charge LED level indicator;
- Display additional parameters on the transceiver screen;
- The aluminum radiator provides effective cooling of the transceiver;
- Folding kickstands for easy operation and transportation.

SPECIFICATIONS:

- Interchangeable Li-Ion 18650 batteries;
- External power supply DC 13-50 V, recommended current 3A;
- Dimensions (L × W × H): 207 × 90 × 21 mm;
- Weight (without batteries): 0.35 kg.

PACKAGE INCLUDES *

- Battery pack BP-500 - 1 pc.
- Battery charger - 1 pc.
- Hex key 3 mm - 1 pc.
- Hex key 2 mm - 1 pc.
- M4 × 25 mm screws - 4 pcs.

Top view

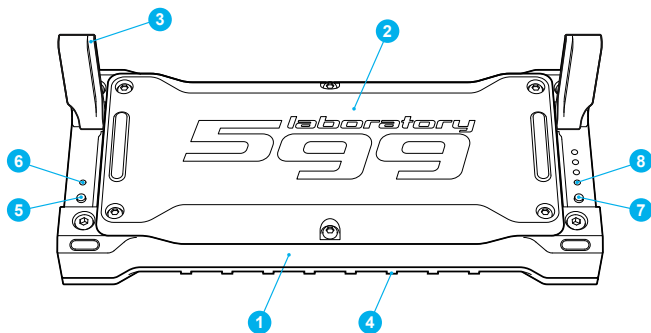

Bottom view

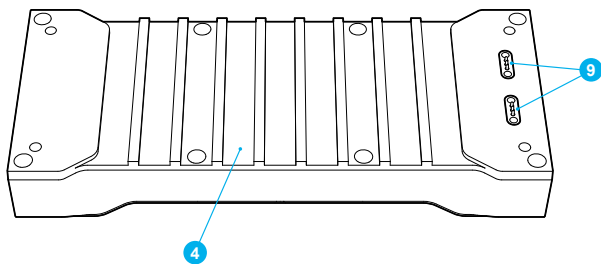

Left view

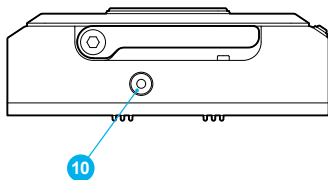

Battery compartment

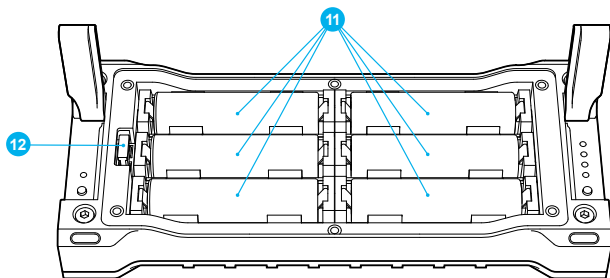

APPEARANCE AND CONTROLS

1. The device enclosure
2. Top cover
3. Kickstands
4. Battery heatsink
5. Power button
6. Operating indicator
7. Battery level check button
8. Battery level indication
9. Contact pads
10. DC charger socket 5.5×2.5 mm
11. Li-Ion 18650 battery holders
12. Fuse, 3A

BATTERIES INSTALLATION AND FUSE REPLACING

! When performing any operation with BP-500 battery pack make sure that the battery pack is turned off (the power indicator is not lit)

1. Remove the top cover of the battery pack (1) by loosening the 6 M3 screws (2) with the 2 mm hex wrench provided.

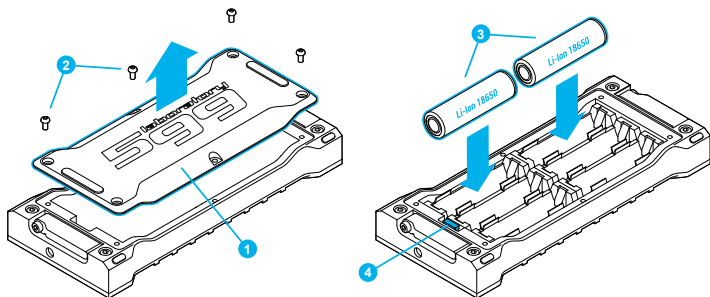

2. Install the Li-Ion 18650 batteries (3) into the battery holders observing the polarity.
3. If necessary, replace the fuse (4), 3A.

It is possible to install 6 or 3 batteries according to the diagram:

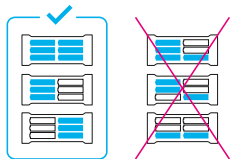
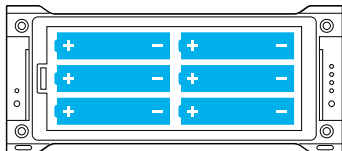

After installing or replacing the batteries, the battery charger must be connected to activate the battery pack.

CONNECTING THE BATTERY PACK TO THE TRANSCEIVER

 Make sure that the battery pack is turned off (the power indicator is not active). Short-circuiting the contact pads of the battery pack while the battery pack is active can cause device damage.

1. Remove the rubber feet that cover the through-mounting holes on the back of TX-500 transceiver.

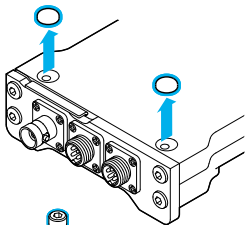

2. According to the location of the contact pads, dock the battery pack and the transceiver and fix it with the supplied M4 × 25 mm screws.

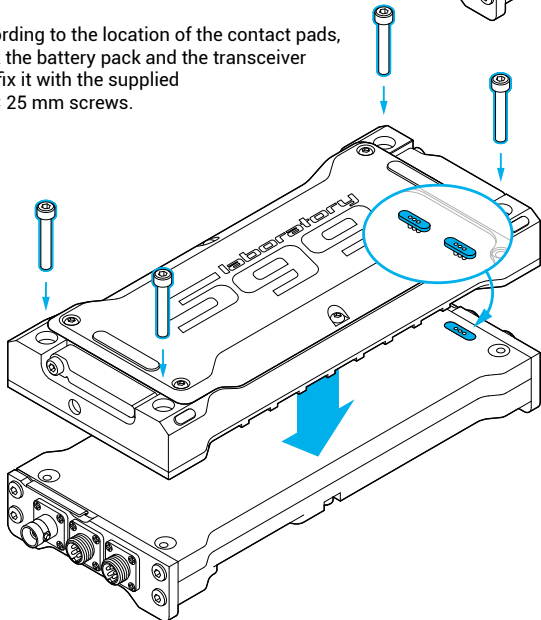

TURNING ON

1. To turn on the battery pack, press and hold the power button (1, Fig. 1) for 1-2 seconds until the power indicator (2) lights up.
2. Within 10 seconds of activating the battery pack, turn on the TX-500 transceiver with the POWER key.

TURNING OFF

1. Turn off the TX-500 transceiver with the POWER key.
2. The battery pack will automatically turn off after 10 seconds of inactivity, and power indicator (2, Fig. 1) will turn off.

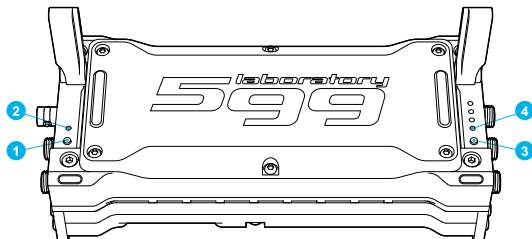

Fig. 1

CHARGE LEVEL CONTROL

To check the battery level, press the button (3, Fig. 1), the four-segment display (4) will show the charge level corresponding to in percent: 25, 50, 75, 100%.

When the battery pack is connected to the TX-500 transceiver, advanced battery parameters indication is available on the transceiver screen. To call up the battery monitor on the on-screen menu, activate the "BAT" function (1, Fig. 2). The transceiver will display the battery input voltage (2), the battery charge level (3), the battery power consumption or the charging power, if the battery pack is in charge mode (4).

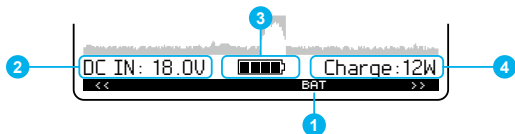
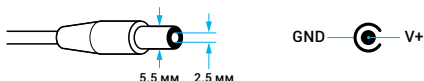

Fig. 2

CHARGING AND EXTERNAL POWER

! Make sure that the input supply voltage of the used charger does not exceed 50V.

To charge the BP-500 battery pack, connect a DC 13-50V power supply to the DC 5.5×2.5 connector of the pack. The recommended power supply current is 3A.



The BP-500 will not charge if an external power source is connected to the TX-500. If the battery pack is active, it will provide backup power if the transceiver's external power supply is undervoltage (below battery pack voltage) or if external power is lost.

Solar panel cells can be used as a charging source, providing an output voltage in the range of 13 to 50 V.

External power connection options:

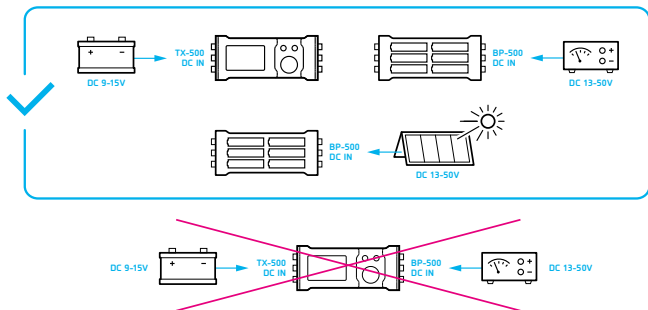

! Do not connect external power sources to the transceiver and battery pack at the same time.

SAFETY REQUIREMENTS



Do not short-circuit the contact pads on the back of the device while the device is turned on (power indicator light is on), this may cause device damage.

- The device must not be serviced (opened for the purpose of replacing batteries or fuses) while it is turned on.
- Do not connect power sources to the device that do not meet the specifications for this device.
- Do not connect external power sources at the same time to the TX-500 transceiver and the battery pack connected to it.
- Do not exceed the input charging voltage of 50V or more.
- Do not wrap or cover the unit during operation.
- Do not leave the device unattended with the power supply connected to it.
- Do not use the device while connected to the TX-500 transceiver during a lightning storm.
- Avoid getting moisture inside the product.
- Immediately turn off the product in case of smoke, burning smell, temperature rise in the room where the product is located.
- The product must not fall into the hands of children.

The device has several protection modes:

REVERSE POLARITY PROTECTION

The BP-500 battery pack has polarity reversal protection, the battery pack cannot be charged if the polarity of the power source is reversed. When using third-party chargers or adapters, make sure that the power plug (DC 5.5×2.5 mm) is correctly pinned.

OVERHEAT PROTECTION

The BP-500 battery pack has built-in overheating protection. If the temperature rises above the recommended value, the transceiver screen will display the overheat warning sign "HOT!".

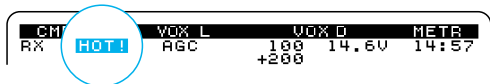

If the temperature rises further, above the limit value, the battery pack will turn off and the power will be blocked, while the transceiver will block the transmission mode.

After the temperature drops, the battery pack and the transceiver will automatically release the power-on and transmission lock.

OPERATING AND STORAGE CONDITIONS

- The device must only be used in accordance with its technical purpose.
- The product is suitable for operation at ambient temperature from -5°C to 35°C and humidity up to 100%.
- The product is designed for both indoor and outdoor use.
- The product has limited protection against external precipitation (moisture and dust).
- Do not place near heat sources.
- Do not immerse in water.
- The product must be stored at ambient temperature from plus 10°C to 35°C and humidity up to 85%.
- The materials used in the product do not have special requirements to recycling.
- The service life of the product is 5 years.

599 *laboratory*

Lab599 inc.
www.lab599.com